



Rational Systems



BAGNI INDUSTRIALIZZATI

PREFABRICATED BATHROOMS

BAIN PREFABRIQUES

FERTIGBADEZIMMER



AZIENDA CERTIFICATA ISO 9001 - ISO 14001

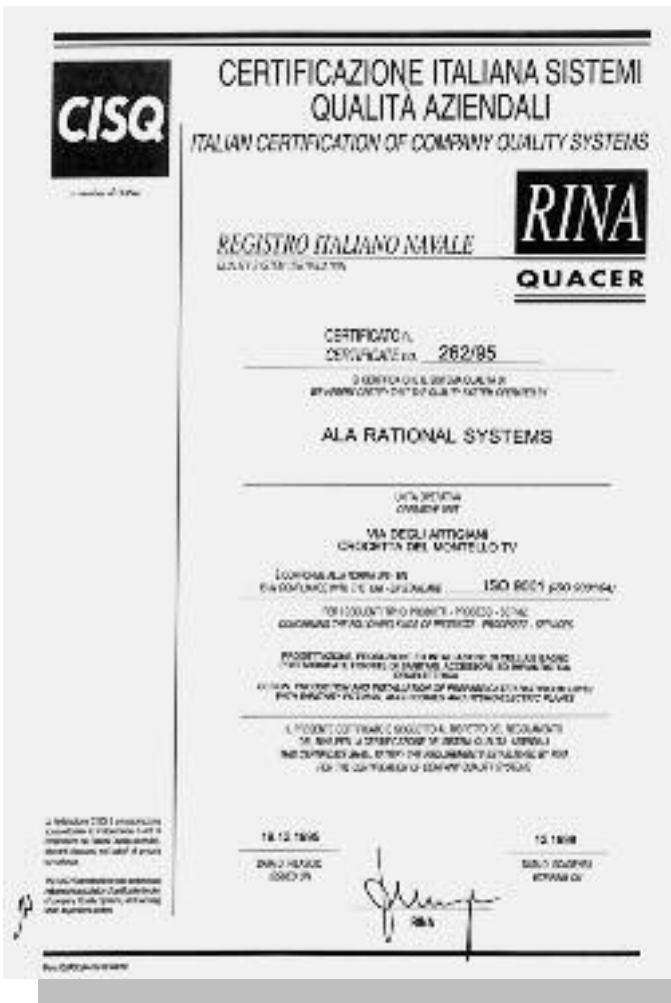

ALA rational systems s.r.l.

Via degli Artigiani 20 - Zona Industriale - 31035 CROCETTA DEL MONTELLO (TV)
Tel. 0423.639223 - Fax 0423.630050

E-mail alarational@alarational.it Sito Internet <http://www.alarational.it>



Rational Systems

Dal 1978 progetta, produce e installa un'ampia e diversificata gamma di cellule bagno industrializzate, realizzate con pannelli componibili in acciaio e poliuretano espanso.

Le cellule ALA vengono installate in un giorno, complete di sanitari, accessori, impianto idrico e impianto elettrico.

La finitura interna delle pareti e del pavimento può essere scelta tra piastrelle in ceramica o in marmo, stucco veneziano, marmorino, vinile antigraffio, gomma antisdrucchiolo.

Since 1978 Ala Rational Systems has been designing, manufacturing and installing a wide range of industrialized bathroom cells made using steel and expanded polyurethane insulated sectional panels. **The ALA bathroom cells** can be installed in one day and are delivered complete with all the sanitary fittings, accessories, plumbing and electrical systems.

Several different interior wall and floor finishings are available: ceramic or marble tiles, Venetian stucco, marmorino, scratch-proof vinyl and non-skid rubber.

Depuis 1978 Ala Rational Systems conçoit, produit et installe une vaste gamme de cellules bain industrialisées faites avec des cloisons modulaires isolées en acier et polyuréthane expansé.

Les cellules bain ALA peuvent être installées dans une journée et elles comprennent tous les sanitaires, accessoires, tuyauteries et l'installation électrique.

Une vaste gamme de finitions intérieures est disponible: carrelages en céramique ou marbre, stuc venetien, marmorino, vinyle antiégratignure ou caoutchouc antidérapant.

Ala Rational Systems plant, produziert und instaliert seit 1978 eine reiche und vielseitige Auswahl industrialisierter Zellbäder, zusammengesetzt mit schalldichten Paneels in Stahl und Schaumpolyurethan.

Diese Zellen ALA werden in einem Tag komplett mit Sanitäreanlage, Zubehör, Wasser und Elektrischer Leitung montiert.

Bei der Innenausführung der Wände und des Bodens kann zwischen Keramikfliesen oder Marmor ausgewählt, werden. Weiters beinhaltet diese Auswahlpalette Marmorino, Venezianischen Stuckverputz, Kratzfesten Vinyl und Rutschfesten Gummi.

IL BAGNO SU MISURA

massima flessibilità nelle dimensioni
e nelle finiture

CUSTOMIZED BATHROOMS

numerous sizes and finishings available

SALLE DE BAIN SUR MESURE

flexibilité des dimensions et des finitions

DAS BAD NACH MASS

Flexibilität in Maßen und Ausfertigung



Rational Systems



FOTO PAG. 3

*Bagno "Linea DOMINO" con Top
lavabo in ceramica, sanitari
sospesi in ceramica, pavimento e
pareti con piastrelle in ceramica,
soffitto laccato.*

Art. 167 del Catalogo

Dimensioni interne cm 150x200.

FOTO PAG. 2

*Bagno "Linea DOMINO" con Top
lavabo in ceramica, sanitari
sospesi in ceramica, pavimento e
pareti con piastrelle in ceramica, .*

Art. 167 del Catalogo

Dimensioni interne cm 150x200.



COSTI CERTI E DEFINITI ALL'ACQUISTO

nessuna sorpresa a consuntivo



FIRM PRICES
according to estimate

PRIX FERME
selon l'évolution

FESTE PREISE
entsprechend schätzung



FOTO PAG. 4 - 5

Bagno "Linea Domino" visto dall'alto e di lato, con Top in ceramica e stucco veneziano.

*Bagno su misura
Dimensioni interne cm 215x160*



SI INSTALLA IN UN GIORNO
perfettamente funzionante e collaudato

ASA
Rational Systems

ONE DAY INSTALLATION
fully tested and operational

MISE EN PLACE DANS UNE JOURNÉE
testé et fonctionnant parfaitement

WIRD IN EINER TAG INSTALLIERT
perfect funktionierend und getestet



FOTO PAG. 7

Bagno "Linea DOMINO" con Top in cristallo supporti cromati e Lavabo sottopiano in ceramica, sanitari sospesi in ceramica, pavimento e pareti con piastrelle in ceramica, stucco veneziano a soffitto. Art. 170 del Catalogo

Dimensioni interne cm 160x230.

Particolare del Top in cristallo con supporti cromati e Lavabo sottopiano in ceramica.

Particolare della Doccia con piatto tondo in ceramica, box in cristallo e colonna idromassaggio.

FOTO PAG. 6

Bagno "Linea DOMINO" con Top lavabo in marmoresina, sanitari sospesi in ceramica, pavimento e pareti in ceramica, soffitto laccato. Art. 161 del Catalogo. Dimensione interne cm 140x200.



SI INSTALLA "CHIAVI IN MANO"

completo di sanitari, accessori
e impiantistica

Rational Systems

COMPLETE INSTALLATION

it is supplied with sanitary fittings, accessories and systems

LIVRÉ COMPLET

fourni avec tous les sanitaires, accessoires et installations

WIR SCHLÜSSELFERTIG GELIEFERT

inklusive Sanitärartikeln, Zubehör, Sanitär und Elektrische Anlagen



FOTO PAG. 9

Bagno "Linea DOMINO" con Top lavabo in Surell®, sanitari sospesi in ceramica con vasca idromassaggio, pavimento con seminato veneziano, pareti con laminato stucco veneziano e vinile antigraffio, soffitto laccato. Articolo non a Catalogo, eseguito su misura. Dimensioni interne cm 210x210

Particolare del Top che fa corpo unico con il Lavabo, entrambi in Surell®.

Particolare del pavimento in seminato veneziano con monogramma dell'Albergo.

•

FOTO PAG. 8

Bagno "Linea DOMINO" con Top lavabo in ceramica, sanitari sospesi in ceramica, pavimento e pareti con piastrelle in ceramica, soffitto laccato.

*Art. 167 del Catalogo
Dimensioni interne cm 215x160*



PESO MOLTO CONTENUTO

il bagno ideale per le ristrutturazioni

LIMITED WEIGHT

The bathroom for renovation

POIDS LIMITÈ

Le bain idéal pour les restructurations

LEICHTGEWICHT

ideales Bad für die Restaurierung



Rational Systems



FOTO PAG. 11

*Bagno "Linea DOMINO" con
Top lavabo in marmoresina
Bagno su misura
Dimensioni interne cm 202x236.*

FOTO PAG. 10

*Bagno "Linea DOMINO" con
Lavabo in ceramica, sanitari so-
spesi in ceramica, pavimento e
pareti in ceramica.
Bagno su misura
Dimensioni interne cm 202x236.*



OTTIMO ISOLAMENTO TERMICO ED ACUSTICO per soddisfare tutte le esigenze

OPTIMAL HEAT INSULATION AND SOUND-PROOFING
to satisfy all needs

ISOLATION THERMIQUE ET ACOUSTIQUE
pour satisfaire tous les exigences

HÖCHST THERMO-AKUSTISCHE ISOLIERUNG
für höhere Ansprüche

ASA
Rational Systems



FOTO PAG. 13

Bagno "Linea DOMINO" con
Top lavabo in marmoresina, sa-
nitari sospesi in ceramica, pavi-
mento con mosaico, pareti in
marmorino, stucco veneziano a
soffitto.

Art. 167 adattato su misura.

Dimensioni interne cm 150x225

FOTO PAG. 12

Antibagno "Linea DOMINO"
con mobile a doppio lavabo in
ceramica. sanitari a pavimento,
pavimento in ceramica e mar-
mo. pareti laccat con decori,
soffitto laccato

Art. 153 del Catalogo.

Dimensioni interne cm 252x177.



FACILMENTE ISPEZIONABILE

interventi senza demolizioni

EASY ACCESS FOR INSPECTION
no demolishing required

FACILITÉ D' INSPECTION
aucune démolition nécessaire

ANLAGE LEICHT ZÜNGLICH
eventuelle Inspektion ohne Demolierung



Rational Systems



FOTO PAG. 15

Bagno "Linea DOMINO" con Top in marmo Rosso Asiago e Lavabo sottopiano in ceramica, sanitari sospesi in ceramica con vasca idromassaggio, pavimento in quadrotti di marmo Perlino Rosato, pareti in quadrotti di marmo Rosso Asiago e marmorino.
Art. 173 del Catalogo
Dimensioni interne cm 202x236

FOTO PAG. 14

Bagno "Linea DOMINO" con Top in marmo Rosso Asiago e Lavabo sottopiano in ceramica con vasca idromassaggio, pavimento in quadrotti di marmo Perlino Rosato, pareti in quadrotti di marmo Rosso Asiago e marmorino.
Art. 173 del Catalogo
Dimensioni interne cm 202x236



MINI BIG

il bagno con mini dimensioni
e grandi prestazioni

MINI BIG
small-size great performance bathroom

MINI BIG
le petit bain avec une grande performance

MINI BIG
das Bad mit kleinem Raumbedarf und großer Leistung

ASA
Rational Systems

FOTO PAG. 17

Bagno "Linea MINI BIG" con lavabo in ceramica, sanitari sospesi in ceramica, pavimento con piastrelle in ceramica, pareti con PVC decorato, soffitto laccato. Art. 310 del Catalogo
Dimensioni interne cm 100x120.



FOTO PAG. 16

Bagno "Linea MINI BIG" con lavabo in ceramica, sanitari sospesi in ceramica, pavimento con piastrelle in ceramica, pareti in vinile anti-graffio (foto a sinistra) e con piastrelle in ceramica (foto a destra), soffitto laccato. Art. 310 del Catalogo - Dimensioni interne cm 100x120.





BAGNI PER ALBERGHI E COMUNITÀ











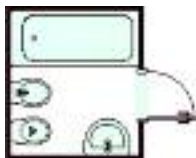

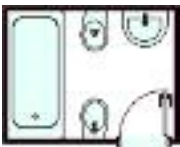
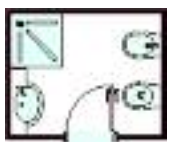

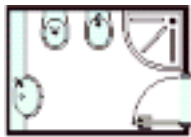
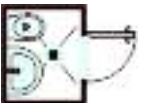
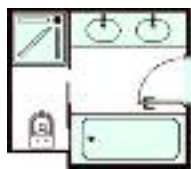
Art.	Linea DOMINO	Dim. esterne cm	Descrizione	Art.	Linea DOMINO	Dim. esterne cm	Descrizione
130 131 132 133		206x120	lavabo+wc+doccia bidet+wc+doccia lavabo+wc+bidet lavabo+bidet+doccia	142		160x160	top lavabo+wc+ bidet sospesi+doccia
133/N		206x120	lavabo+wc+bidet+doccia	150		240x190	top lavabo+wc+ bidet sospesi+doccia
134		254x120	lavabo+wc+bidet+doccia	151		200x170	top lavabo+wc+ bidet sospesi+doccia
135		254x115	lavabo+wc+bidet+ vasca a sedere	153		262x187	mobile con doppio lavabo+ wc sospeso+ doccia
136		225x130	lavabo+wc+bidet+doccia	160		210x160	lavabo+wc+ bidet sospesi+doccia
137		225x130	lavabo+wc+bidet+doccia	161		210x150	top lavabo+wc+ bidet sospesi+doccia
138		210x150	top lavabo+wc+ bidet sospesi+doccia	162 adattabile		200x175	lavabo+wc+bidet+doccia bagno "adattabile" trasformabile in "accessibile" con l'eliminazione del bidet (D.M. 236/89)
140		157x157	lavabo+wc+ bidet sospesi+doccia	164 adattabile		260x190	top lavabo+wc+ bidet sospesi+doccia bagno "adattabile" trasformabile in "accessibile" con l'eliminazione del bidet (D.M. 236/89)
141		157x157	lavabo+wc sospeso+ doccia	165		200x180	top lavabo+wc+ bidet sospesi+vasca

BATHROOM FOR HOTELS AND COMMUNITIES

SALLES DE BAIN POUR HÔTELS ET COMMUNAUTÉS

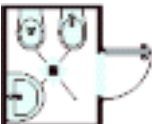
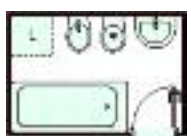
BÄDER FÜR HOTELS UND GEMEINDE

Art.	Linea DOMINO	Dim. esterne cm	Descrizione	Art.	Linea MINI BIG	Dim. esterne cm	Descrizione
165-A		200x180	lavabo+wc+bidet+vasca	186		250x160	lavabo+wc+bidet sospesi+doccia+attacco lavatrice
167 168		210x160	top lavabo+wc+bidet sospesi+doccia lavabo+wc+bidet sospesi+doccia	188		230x180	lavabo+wc+bidet sospesi+vasca
169		210x170	top lavabo+wc+bidet sospesi+doccia	195		190x200	top lavabo+wc+bidet sospesi+doccia
170		240x170	top lavabo+wc+bidet sospesi+doccia	310 320		110x130 110x130	lavabo+wc sospeso+doccia lavabo+wc sospeso con tavoletta bidet+doccia
172		285x250	top con doppio lavabo+wc sospeso+vasca idromassaggio+doccia	340		130x110	lavabo+wc sospeso+doccia
173		202x236	top lavabo+wc+bidet sospesi+vasca idromassaggio	350		180x110	lavabo+wc+bidet sospesi+doccia
174		265x180	top lavabo+wc+bidet sospesi+vasca	352		180x110	lavabo+wc+bidet sospesi+doccia
175		310x180	top lavabo+wc+bidet sospesi+vasca+doccia	370		130x160	lavabo+wc+bidet sospesi+doccia
185		260x180	lavabo+wc+bidet+vasca+attacco lavatrice	380		160x130	lavabo+wc+bidet sospesi+doccia

IL RISPETTO DELLA NORMATIVA nel bagno per Disabile



CONFORMITY WITH THE LAWS IN FORCE
in the bathroom for the disabled

CONFORMITÉ AVEC LES LOIS EN VIGUEUR
des salles de bain pour handicapés

GENAUES EINHALTEN DER VORSCHRIFTEN
für Behindertenbäder



FOTO PAG. 21

Bagno "Linea DISABILE" tipo Accessibile, con lavabo sagomato in ceramica, sterilizzatore con sifone e miscelatore con doccetta estraibile, sanitari sospesi in ceramica a norma, pavimento con piastrelle antiscivolo in ceramica con sguscia, pareti in vinile antigraffio, soffitto laccato, lavapadelle in acciaio inox, accessori e ausili per disabile a norma.

Art. 472 del Catalogo
Dimensioni interne cm 200x200

FOTO PAG. 20

Bagno "Linea DISABILE" tipo Accessibile, con lavabo in ceramica, sanitari sospesi in ceramica a norma, pavimento con piastrelle antiscivolo in ceramica, pareti in vinile antigraffio, soffitto laccato, accessori e ausili per disabile a norma.

Art. 468 del Catalogo
Dimensioni interne cm 180x200.



CURA NELLE FINITURE

nel bagno per Disabile

ATTENTION PAID TO FINISHINGS
in the bathroom for the disabled

FINITIONS SOIGNÉE
des salles de bain pour handicapés

GEPFLEGTE AUSFÜHRUNG
des Behindertenbades



Rational Systems



FOTO PAG. 22 - 23

*Bagno "Linea Disabile" tipo
Adattabile, con Top lavabo in cerami-
ca, sanitari sospesi in ceramica, pav-
imento e pareti con piastrelle in cera-
mica, soffitto in laccato. Bagno facil-
mente trasformabile in bagno accessi-
bile mediante pochi cambiamenti ai
sanitari e agli ausili, senza dover inter-
venire sulla struttura.
Art 164 del catalogo
Dimensioni interen cm 250x180*



LA CURA NELLE FINITURE nel bagno per Disabile

ASA
Rational Systems

ATTENTION PAID TO FINISHINGS
in the bathroom for the disabled

FINITIONS SOIGNÉES
des salles de bain pour handicapés

GEPFLEGTE AUSFÜHRUNG
des Behindertenbades



FOTO PAG. 25

*Elegante e funzionale bagno per disabile studiato per ambiente alberghiero quando non si desidera mettere in risalto l'uso disabile del bagno
Bagno su misura
Dimensioni interne cm 290x150*

Particolare doccia a filo pavimento con sedile ribaltabile

Particolare vaso sospeso, montato ad altezza specifica per disabile

FOTO PAG. 24

*Bagno "Linea DISABILE" tipo Accessibile, con lavabo in ceramica, sanitari sospesi in ceramica, pavimento con piastrelle antiscivolo in ceramica, pareti rivestite in legno, soffitto laccato, accessori e ausili per disabile a norma.
Articolo non a Catalogo, eseguito su misura
Dimensioni interne cm 176x190*



FINITURE INTERNE INNOVATIVE

nel bagno per Disabile



Rational Systems

INNOVATIVE INNER FINISHES
in the bathroom for the disabled

FINITIONS INTÉRIEURES INNOVATRICES
dans le salles de bain pour handicapés

ERFINDERISCHE INNER ENDE
im Badeyimmer für Handikap



Foto pag 27

*Bagno per disabile per esterno
con dotazione specifica per
disabile, pavimento antiscivolo
senza giunte con sguscia e
doccia incassata
Bagno su misura
Dimensioni interen cm
220x165*

FOTO PAG. 26

*Vista dall'esterno del bagno di
pag.27 in occasione della
ristrutturazione il bagno è
stato posizionato sulla terrazza
a coppie con vano tecnico
centrale pedonabile*



easyopen

PORTA RORTOTRASLANTE



Rational Systems

REVOLVING AND TRANSLATING DOOR
PORTE TOURNANT ET DE ROTATION
ROTOTRANSLATIONSTÜR



FOTO PAG. 29

Porta **Easyopen** nel suo movimento di rototraslazione che combinato con l'eliminazione dei battenti consente l'apertura sempre a "spingere" sia in entrata sia in uscita rappresentando così la soluzione ideale al problema delle barriere architettoniche per i portatori di handicap e rispondendo a quanto previsto dal D.Lgs. 626/94 sulla sicurezza degli ambienti di lavoro.

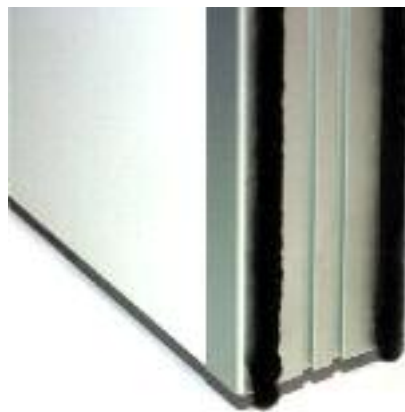

FOTO PAG 29

Particolari costruttivi: maniglia con chiusura libero/occupato; profilo di alluminio con spazzole di tenuta; dettaglio del meccanismo di rototraslazione.

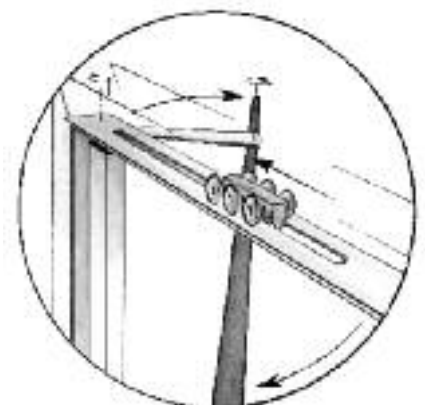

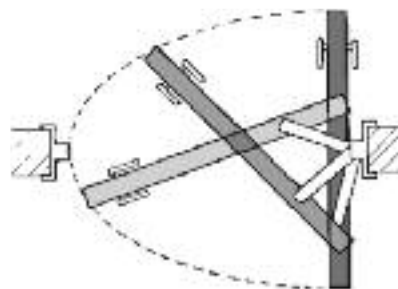

1 anta

LARGHEZZA

passaggio utile	805	855	905	955	1005	1055	1105	1155
falsotelaio	935	985	1035	1085	1135	1185	1235	1285

ALTEZZA

passaggio utile	2052	2102	2152	2202
falsotelaio	2122	2172	2222	2272

2 ante

LARGHEZZA

passaggio utile 1 anta	905	905	905	855
passaggio utile 2 ante	1204	1304	1404	1404
falsotelaio	1380	1480	1580	1580

ALTEZZA





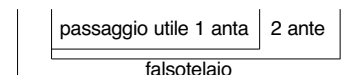
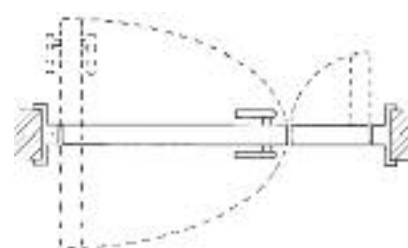
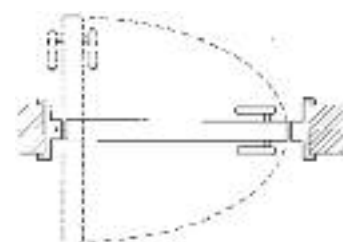
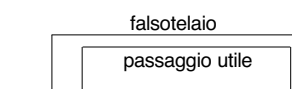

passaggio utile	2052	2102	2152	2202
falsotelaio	2122	2172	2222	2272

easyopen, nella versione a due ante, è dotata di una porta rototraslante con apertura da entrambi i lati ed una semifissa a volata circolare. Il passaggio utile scelto per l'anta rototraslante, determina per differenza, la misura dell'anta semifissa, nota la dimensione del falsotelaio

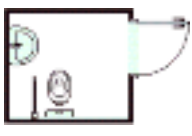
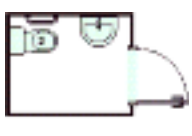

BAGNI PER OSPEDALI & R.S.A.









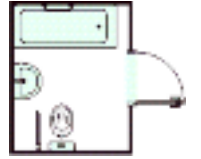

Art.	Linea DISABILE	Dim. esterne cm	Descrizione
426		190x190	lavabo+wc+ausilii a norma Rotazione a 360° della sedia a ruote
462 162 trasformato		200x175	lavabo+wc+ausilii a norma Rotazione a 180° con manovra combinata della sedia a ruote (Art. 162 adattato)
463		200x160	lavabo+wc sospeso+ ausilii a norma Rotazione a 180° della sedia a ruote
464		200x170	lavabo+wc+doccia+ ausilii a norma Rotazione a 180° della sedia a ruote
465		175x200	lavabo+wc+doccia+ ausilii a norma Rotazione a 180° con manovra combinata della sedia a ruote
466		190x190	lavabo+wc+doccia+ ausilii a norma Rotazione a 360° della sedia a ruote
467		210x210	lavabo+wc+bidet+doccia+ ausilii a norma Rotazione a 360° della sedia a ruote
468		210x190	lavabo+wc+bidet+doccia+ ausilii a norma Rotazione a 180° con manovra combinata della sedia a ruote
469		260x175	lavabo+wc+bidet+doccia+ ausilii a norma Rotazione a 180° con manovra combinata della sedia a ruote

BATHROOM FOR HOSPITALS AND SIMILAR FACILITIES

SALLES DE BAIN POUR HÔPITAUX ET STRUCTURES SIMILAIRES

BÄDER FÜR KRANKENHÄUSER UND ALTESHEIM

Art.	Linea DISABILE AD USO PUBBLICO	Dim. esterne cm	Descrizione
470		310x195	lavabo+wc+bidet+doccia+ ausilii a norma Rotazione a 180° con manovra combinata della sedia a ruote
471		200x250	lavabo+wc+vasca+ ausilii a norma Rotazione a 180° con manovra combinata della sedia a ruote
472		210x210	lavabo+wc+doccia+ ausilii a norma+lavapadelle Rotazione a 360° della sedia a ruote
421		295x160	wc+ausilii a norma, con antibagno Nessuna rotazione nel bagno e rotazione a 180° nell'antibagno, della sedia a ruote
422		330x180	lavabo+wc+ausilii a norma, con antibagno Rotazione a 180° con manovra combinata nel bagno e nell'antibagno, della sedia a ruote
423		335x175	lavabo+wc+ausilii a norma, con antibagno Rotazione a 180° con manovra combinata nel bagno e nell'antibagno, della sedia a ruote
424		355x175	lavabo+wc+ausilii a norma, con antibagno Rotazione a 180° con manovra combinata nel bagno e nell'antibagno, della sedia a ruote
425		355x160	lavabo+wc sospeso+ ausilii a norma, con antibagno Rotazione a 180° nel bagno e nell'antibagno, della sedia a ruote
427		345x190	lavabo+wc+ausilii a norma, con antibagno Rotazione a 360° nel bagno e a 180° con manovra combinata nell'antibagno, della sedia a ruote

ELEGANZA E FUNZIONALITÀ per l' Ufficio



FUNCTIONAL AND ELEGANT
for the office

CARACTÈRE FONCTIONNEL ET ÉLÉGANT
pour le bureau

ELEGANZ UND FUNKTIONALITÄT
für das Büro



FOTO PAG. 31

Bagno "Linea USO PUBBLICO-UFFICIO" con lavabo in ceramica, WC a pavimento, pavimento con piastrelle in ceramica, pareti in vinile antigraffio, soffitto laccato.

Art. 210 del Catalogo
Dimensioni interne cm 120x196.



FOTO PAG. 30

Bagno "Linea USO PUBBLICO-UFFICIO" con piano lavabo in Surell®, sanitari sospesi in ceramica, pavimento con gomma e sguscia, pareti in acciaio inox gofrato e in acciaio laccato, soffitto laccato, rubinetti a cellula fotoelettrica.

Articolo non a Catalogo,
eseguito su misura.
Dimensioni interne cm 270x360.

FOTO PAG. 30

(vista dall'alto)
Bagno "Linea USO PUBBLICO-UFFICIO" con lavabo in ceramica, WC a pavimento, pavimento con piastrelle in ceramica, pareti in vinile antigraffio, soffitto laccato.

Art. 210 del Catalogo
Dimensioni interne cm 120x196.



PRATICITÀ E COSTI CONTENUTI

per l' Azienda



PRACTICAL AND CONVENIENT
for the company

UTILITÉ PRATIQUE ET PRIX CONVENABLE
pour la société

PRAKTISCH UND PREISGÜNSTIG
für die Firma

FOTO PAG. 32

*Vista dall'esterno dei bagni.
Finestra a wasistas, grondaia e
pluviale.*



FOTO PAG. 33

*Bagno "Linea USO PUBBLICO-INDUSTRIALE" per uso esterno con lavabi a canale, turche, pavimento in resina, pareti interne ed esterne in vinile antigraffio, soffitto laccato.
Bagno su misura.
Dimensioni interne cm 305x760.*



BAGNI AD USO PUBBLICO

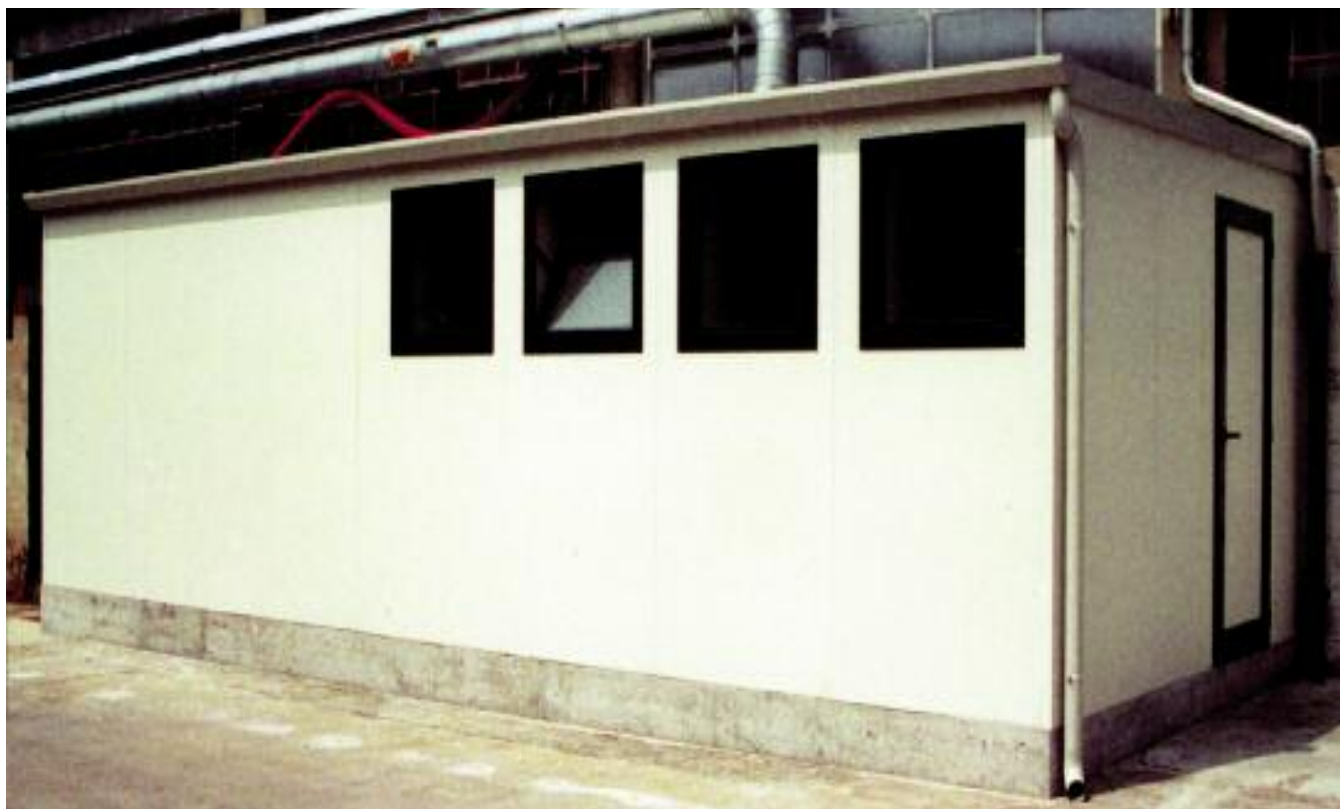







Art.	Linea UFFICIO E INDUSTRIA	Dim. esterne cm	Descrizione
110 111		108x108	solo wc solo lavabo
112		108x108	solo doccia
210		206x130	lavabo+wc
211		206x130	lavabo+wc
212		206x130	lavabo+wc+doccia
213		206x130	lavabo+turca
215		304x120	lavabo+lavabo+wc
216		304x120	lavabo+wc+bidet

Art.	Linea UFFICIO E INDUSTRIA	Dim. esterne cm	Descrizione
217		304x120	lavabo+wc+doccia
220		206x160	lavabo+lavabo+wc
221		206x160	lavabo+wc+doccia
222		206x160	lavabo+wc+bidet
230 232		250x206	lavabo+2 wc lavabo+2 turche
231		250x206	lavabo+wc+doccia
235		304x240	lavabo+2 turche+2orinatori
246		304x132	3 wc

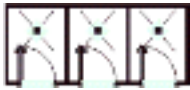
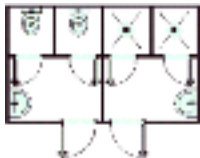
PUBLIC BATHROOMS

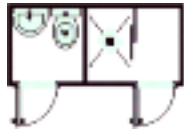
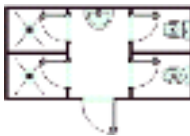
SALLES DE BAINS PUBLIQUES

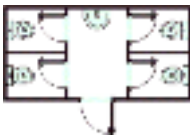
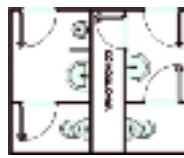
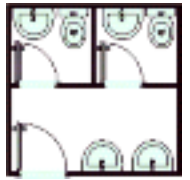
BÄDER FÜR DIE ÖFFENTLICHKEIT

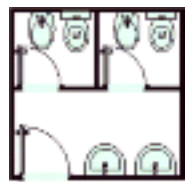
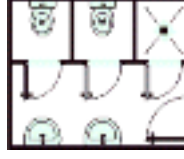
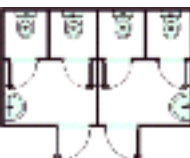
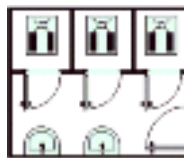
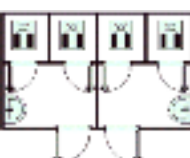
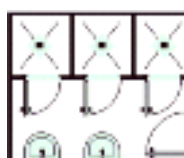
Art.	Linea UFFICIO E INDUSTRIA	Dim. esterne cm	Descrizione	Art.	Linea UFFICIO E INDUSTRIA	Dim. esterne cm	Descrizione
247		245x132	3 docce	272		408x250	2 lavabo+2 wc+2 docce
248		410x132	5 docce	280		260x120	lavabo+wc+doccia
250		408x206	lavabo+2 wc+2 docce	281		260x120	lavabo+wc+doccia
251		408x206	lavabo+4 wc	286		360x290	Bagno per esterno con 2 lavabo+ 2 wc+1 orinatoio
260		254x250	2 lavabo+2 lavabo+2 wc	287		480x268	top con 5 lavabo+5wc
261		254x250	2 lavabo+2 wc+2 bidet	290		304x250	2 lavabo+2 wc+doccia
270		408x250	2 lavabo+4 wc	291		304x250	2 lavabo+3 turche
271		408x250	2 lavabo+4 turche	292		304x250	2 lavabo+3 docce

easywall

creare in libertà
con il sistema modulare di Pareti Divisorie

MAXIMUM CREATIVE FREEDOM
thanks to the modular partitions

LIBERTÉ DE CRÉATION
grâce aux cloisons modulaires

KREATIVITÄT
mit Hilfe des Modularsystems für Trennwände



Rational Systems



FOTO PAG. 37

*Doccia "Linea PARETI DIVISORIE" con pareti in alluminio verniciato a caldo, piedini regolabili, panchetta.
Art. 1063 a Catalogo*

FOTO PAG. 36

Particolari costruttivi: profilo superiore, panchetta, piedini regolabili, cerniera in nylon, maniglia con chiusura libero occupato.



SISTEMA MODULARE PARETI DIVISORIE











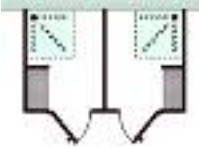

Art.	MODULI BASE	Dim. esterne cm	Descrizione
1041		100x100	parete divisoria+ frontale con porta
1042		100x120	parete divisoria+ frontale con porta
1043		100x100	parete divisoria+ frontale con tenda
1045		200x100	2 pareti divisorie+ 2 frontali con porta
1046		200x120	2 pareti divisorie+ 2 frontali con porta
1047		200x100	2 pareti divisorie+ 2 frontali con tenda
1049		300x100	3 pareti divisorie+ 3 frontali con porta

Art.	MODULI CON SPOGLIATOIO E PANCHETTA	Dim. esterne cm	Descrizione
1050		300x120	3 pareti divisorie+ 3 frontali con porta
1051		300x100	4 pareti divisorie+ 3 frontali con porta
1061		110x150	parete divisoria+ frontale con porta+ spogliatoio con panchetta
1062		110x150	parete divisoria+ frontale con tenda+ spogliatoio con panchetta
1063		220x150	parete divisoria+ 2 frontali con porta+ 2 spogliatoi con panchetta
1064		220x150	2 pareti divisorie+ 2 frontali con porta+ 2 spogliatoi con panchetta
1065		220x150	2 pareti divisorie+ 2 frontali con tenda+ 2 spogliatoi con panchetta

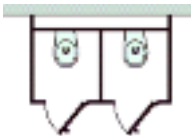
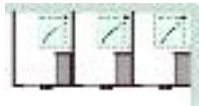
MODULAR PARTITIONS SYSTEM

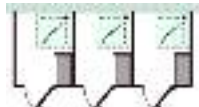
SYSTÈME DE CLOISONS MODULAIRES

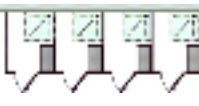
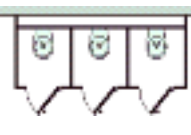
MODULARSYSTEM FÜR TRENNWÄNDE

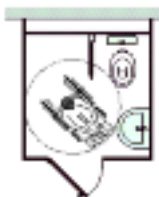
Art.	MODULI CON SPOGLIATOIO E PANCHETTA	Dim. esterne cm	Descrizione	Art.	MODULI CON SANITARI ISPEZIONABILI	Dim. esterne cm	Descrizione
1066		220x150	3 pareti divisorie+ 2 frontali con porta+ 2 spogliatoi con panchetta	2001		100x100	2 pareti divisorie+ 1 frontale con porta+ 1 parete di fondo+1 wc
1067		330x150	2 pareti divisorie+3 frontali con porta+3 spogliatoi con panchetta	2002		100x120	2 pareti divisorie+ 1 frontale con porta+ 1 parete di fondo+1 wc
1068		330x150	3 pareti divisorie+ 3 frontali con porta+ 3 spogliatoi con panchetta	2003		200x100	3 pareti divisorie+ 2 frontali con porta+ 2 pareti di fondo+2 wc
1069		330x150	3 pareti divisorie+ 3 frontali con tenda+ 3 spogliatoi con panchetta	2004		200x100	3 pareti divisorie+ 2 frontali con porta+ 2 pareti di fondo+2 turche
1070		330x150	4 pareti divisorie+ 3 frontali con porta+ 3 spogliatoi con panchetta	2006		250x100	3 pareti divisorie+ 2 frontali con porta+ 2 pareti di fondo+ 2 lavabo+2 wc
1071		440x150	5 pareti divisorie+ 4 frontali con porta+ 4 spogliatoi con panchetta	2007		300x100	4 pareti divisorie+ 3 frontali con porta+ 3 pareti di fondo+ 3 wc
1081 PER DISABILE		180x180	parete divisoria+ frontale con porta (a norma D.M. 236/89)	1082 PER DISABILE		180x180	parete divisoria+ frontale con porta+ parete di fondo+ lavabo+ wc per disabile (a norma D.M. 236/89)

ALA rational systems s.r.l.

Via degli Artigiani 20 - Zona Industriale - 31035 CROSETTA DEL MONTELLO (TV)
Tel. 0423.639223 - Fax 0423.630050

E-mail alarational@alarational.it Sito Internet <http://www.alarational.it>